



DOLPHIN
ALAVO



INSTALLATION GUIDE

AA0100

COMPLIANCE

MODEL NUMBER: UK/EU APPROVALS

- WRAS Approved
- CE Marked



MODEL NUMBERS STARTING: ALV LISTED BY IAPMO R&T to

- IGC 127 Combined Hand-Washing Systems
ASME A112.18.1/CSA B125.1
- Uniform Plumbing Code (UPC)
- National Plumbing Code of Canada
- International Plumbing Code (IPC)
- UL 1951, 2nd Edition
- CAN/CSA C22.2 No. 68-18
- CAN/CSA C22.2 No. 14-18
- UL 962, 4th Edition

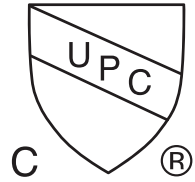

MODEL NUMBERS STARTING: ALV COMPLY with

- ADA
- NSF/ANSI 372 (Lead Free)
- CEC testing (California Energy Commission)
- DOE testing (Department of Energy)(USA)
- Water Efficiency and Sanitation Standard (IAPMO USA)
- California Green Building Standards
- LEED v4.1
- ICC 700 (National Green Building Standard®)
- R-2000 (Natural Resources Canada)
- ANSI/GBI (Green Globes® Assessment Protocol for Commercial Buildings)



CONTENTS

Contact Us	4
------------	---

INSTALLATION INSTRUCTIONS

Parts and Fixings List	6
Pre-Installation	8
Water and Power Requirements	9
Installing Modules	11
Fitting Mirrors	13
Installation Check List	20
Light Control	22

IMPORTANT

Ensure you have read through and understood this document fully before attempting to install an Alavo system.

DOCUMENT REVISION A



The Dolphin Doc M Alavo is a remarkable washroom solution that is designed with innovation and inclusivity in mind. This behind mirror system not only ensures a seamless and functional washroom experience but also incorporates a unique feature for individuals with visual impairments. Its double sized icons provide clear and accessible navigation, enhancing usability and comfort for all users. Doc M Alavo truly redefines washroom accessibility and convenience, making it an essential addition for modern facilities committed to inclusivity and user-friendly design.

CONTACT US

Dolphin
Southpoint, Compass Park
Junction Road, Bodiam
TN32 5BS
United Kingdom

T +44 (0)1424 202 224
E info@dolphinsolutions.co.uk
W dolphinsolutions.co.uk

© Dolphin Solutions Ltd.



DOLPHIN AA0100

PARTS AND FIXINGS LIST

PARTS AND FIXINGS INCLUDED WITH ALAVO

Please ensure you are in possession of all parts and fixings listed below.

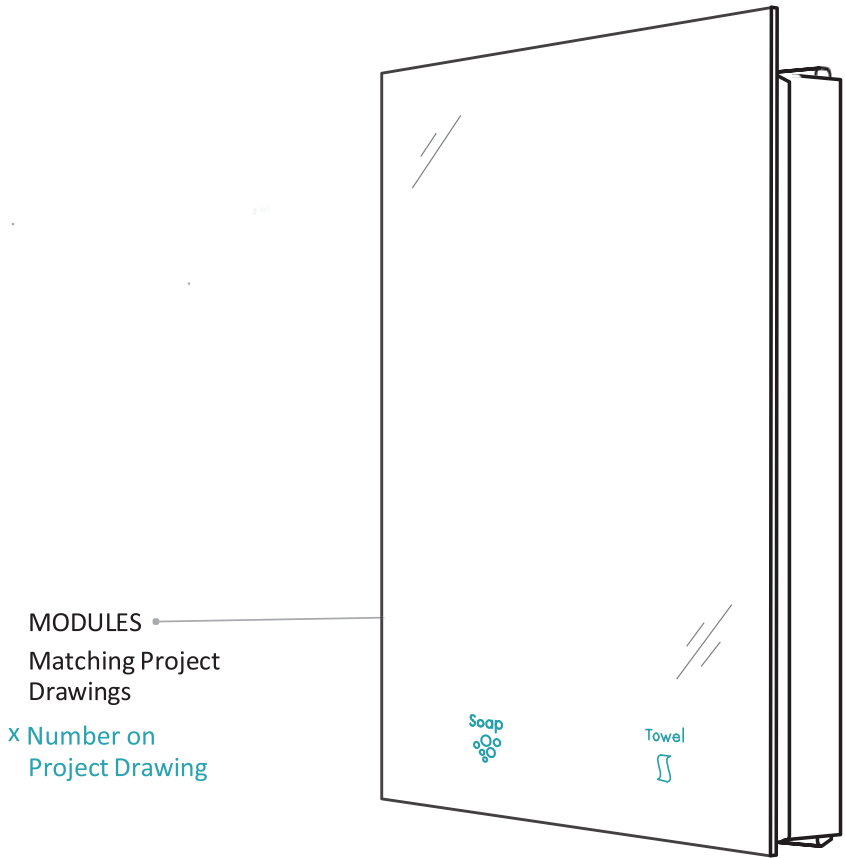

MODULES

Matching Project Drawings

X Number on Project Drawing

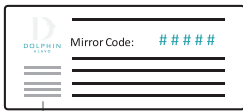

MIRROR LABEL
Identifying Mirror
x 1 per Mirror
ON MIRROR



MODULE LABEL
Identifying Module
x 1 per Module
ON MODULE

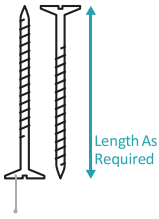

SCREWS

Fixing
Installation
Bracket

xAs
Required
NOT SUPPLIED

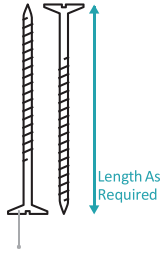

SCREWS

Fixing
Modules

xAs
Required
NOT SUPPLIED

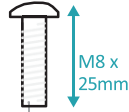

BOLTS

Attaching
Hinges

x1 per
Hinge



BOLTS

Attaching Strut
Brackets

x2 per
Strut

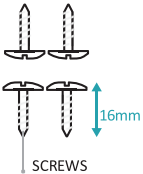

SCREWS

Attaching Light
Sensor

x 4 per Light
Sensor

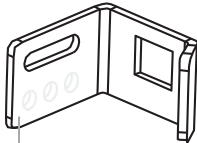

LOCK KEEP

Locking
Mirror

x1

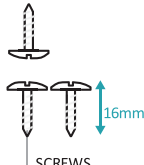

SCREWS

Attaching Lock
Keep

x3 per Lock Keep

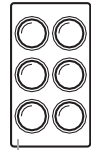

MOUNT BUTTONS

Buffer Behind
Mirror

x 2 per
Mirror

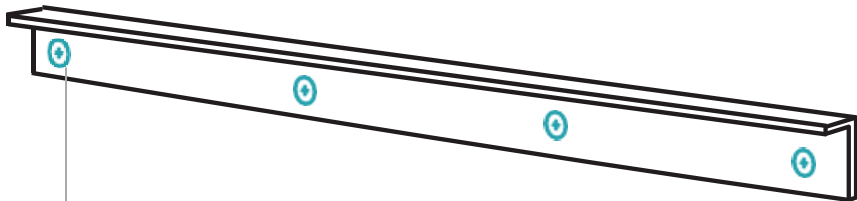

500mm SUPPORT RAIL
Supporting Module

PRE - INSTALLATION

KEY STEPS BEFORE INSTALLING

Please ensure all steps have been completed before fixing the Alavo system in your washroom.

01 PROJECT DRAWINGS

Ensure you have the correct AA0100 drawing.

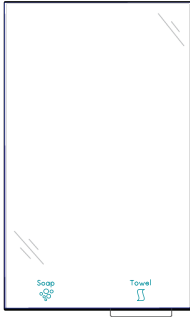

03 FOR MASONRY WALLS

Masonry walls require a minimum of 18mm thick plywood on studs before Alavo is installed.

All brackets must be installed directly to a structural lining, not on a decorative finishing board.

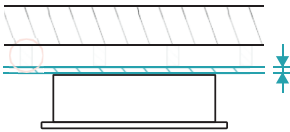

NOTE

It is essential to achieve full penetration of the fixing screws through the 18mm cladding.

05 SUPPORT RAIL

Fix the support rail using a recommended screw diameter of 5mm.

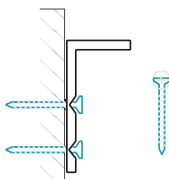

02 FOR STUD WALLS

Stud walls require a minimum of 18mm thick plywood cladding before Alavo is installed.

All brackets must be installed directly to a structural lining, not on a decorative finishing board.

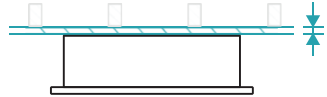

NOTE

It is essential to achieve full penetration of the fixing screws through the 18mm cladding.

04 INSTALLATION HEIGHT

Measure height from finished floor level to top of trough / basin to ensure correct positioning.

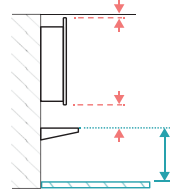

NOTE

See project drawing and account for overhang of mirrors from modules.

Refer to project drawing and DocM for mounting heights

06 FIXING SCREWS

Use fixing holes to secure Alavo to the wall using a minimum screw diameter of 5mm. Extra holes can be drilled as required.

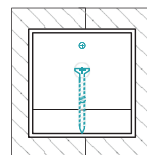

****IT IS THE CONTRACTOR'S RESPONSIBILITY TO ENSURE THERE IS SUFFICIENT STRENGTH IN THE WALL AND FIXINGS TO SUPPORT ALAVO****

WATER AND POWER REQUIREMENTS
WATER REQUIREMENTS

Plumbing and pressure requirements when installing the Alavo system.

IT IS THE RESPONSIBILITY OF THE PLUMBER:

-To connect the system according to regulations and industry standards, and to adjust the plumbing if required.

CONNECTIONS

A hot loop is provided and should be isolated if not required.

The entry point positioning of the water supply is critical and can be found on

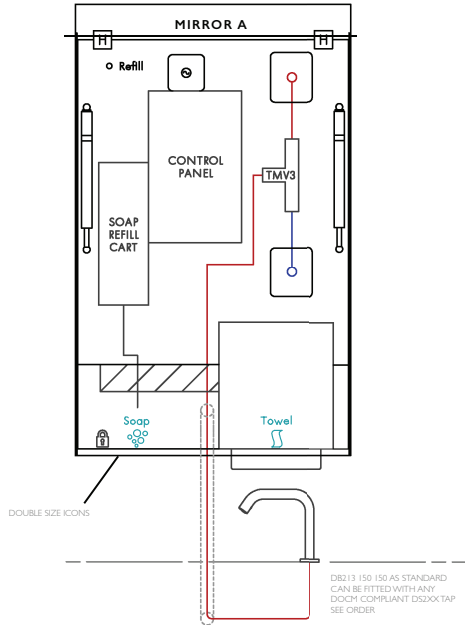

NOTE

Connections should be carried out by a qualified plumber.

FEED DIAMETER

Depending on the model of Alavo, fittings accept / connect to either 15mm or 1/2" CTS (copper tube size) feeds.

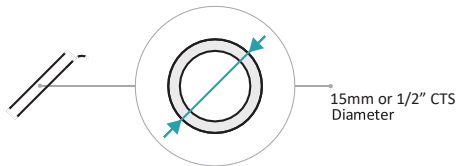

PRESSURE

A pressure of 1 to 6 bar is required, and for best results 2 to 3 bar is recommended.

The hot and cold supplies should be balanced.

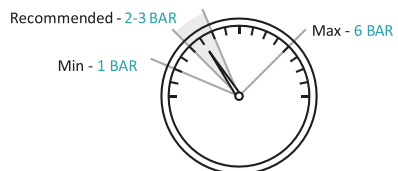

POWER REQUIREMENTS

Wiring and power requirements when installing the Alavo system.

IT IS THE RESPONSIBILITY OF THE ELECTRICIAN:

- To connect the system according to regulations. Connections should be carried out by a qualified electrician.

CONNECTIONS & SUPPLY

The entry point positioning for the power supply is critical.

Cable/conductor insulation colour scheme to be used in accordance with the local regulations.

Standard local mains input voltage of either 110V or 230V AC ~ single phase supply is required.

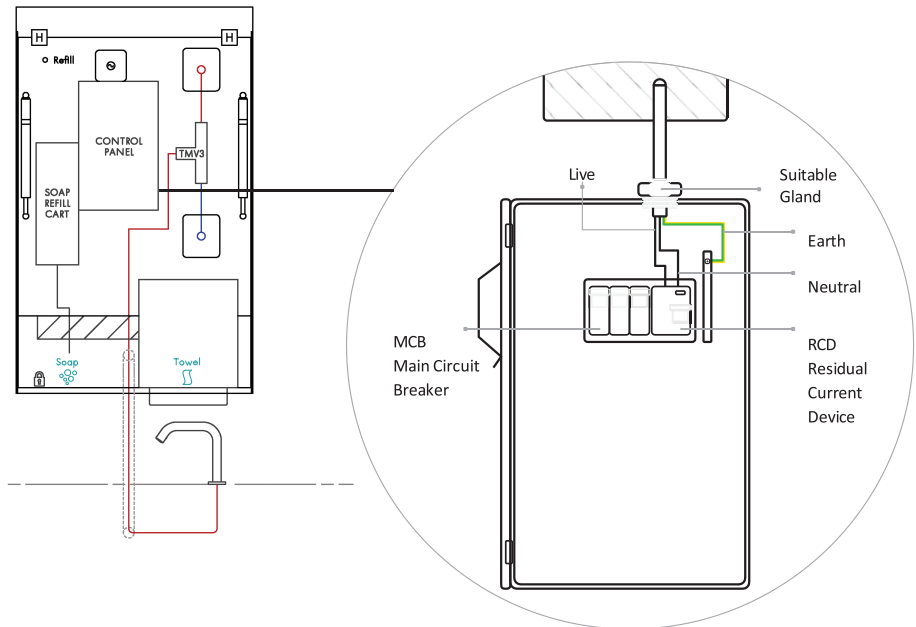

INSTALLING MODULE
BEFORE YOU START

Ensure you have all of the parts and fixings listed below.

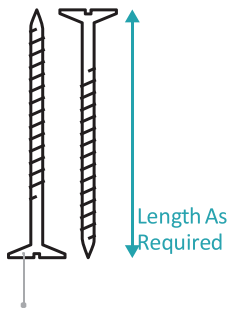

SCREWS
Fixing
Installation
Bracket
x NOT SUPPLIED

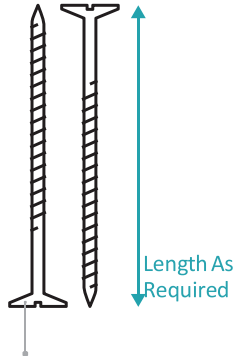

SCREWS
Fixing
Module
x NOT SUPPLIED



MODULE LABEL
Identifying
Module
x 1 per
Module
ON MODULE

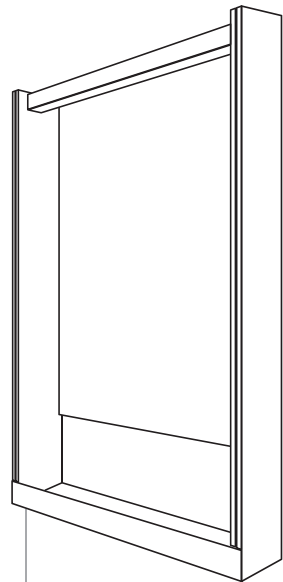

MODULES
Matching Project
Drawings
x Number on
Project Drawing

01 FIX THE SUPPORT RAIL

Mark all datums on the wall and fix the support rail in the correct location as shown below. A recommended screw diameter of 5mm should be used. Check all brackets that make up the rail are level and secure.

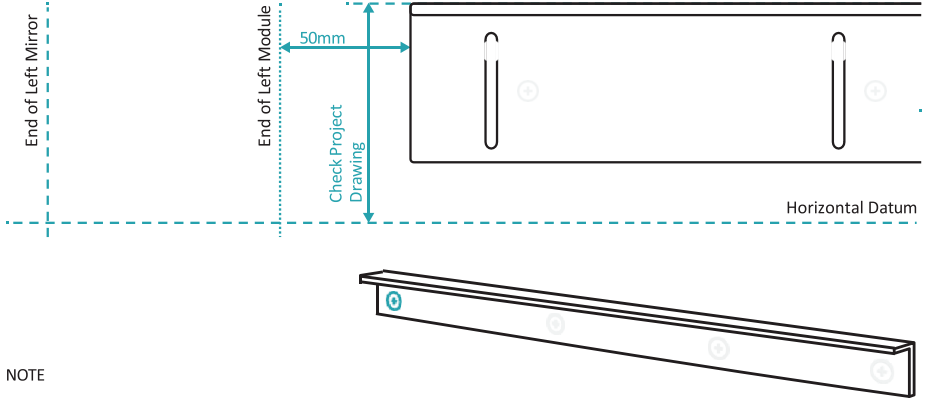

NOTE

Ensure relationship between the datum, module and the support rail are correct.

**** MINIMUM OF TWO OPERATIVES SHOULD BE UTILISED FROM HERE ON ****

System weighs 60KG per metre

02 DETERMINE NUMBER OF MODULES

Lift module onto the support rail and fix securely to the wall using all screw holes.

Continue to Fitting Mirrors on Page 16.

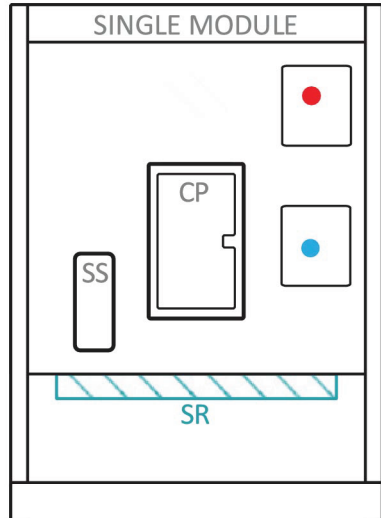

FITTING MIRROR BEFORE YOU START

Ensure you have all of the parts and fixings listed below.

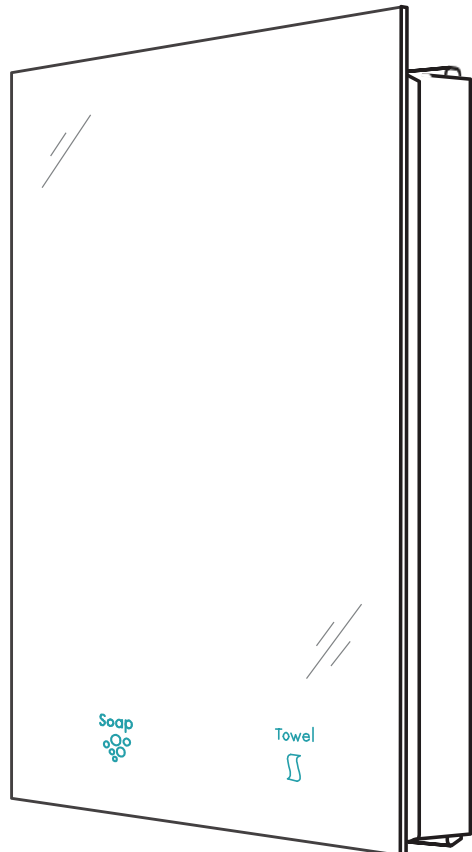
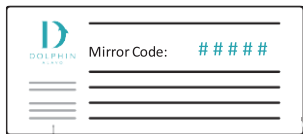

01 SLACKEN MIRROR HINGES

Slacken the bolts on the mirror hinges to allow them to slide easily along the rail. The hinges will already be attached to the hinge rail on the modules.

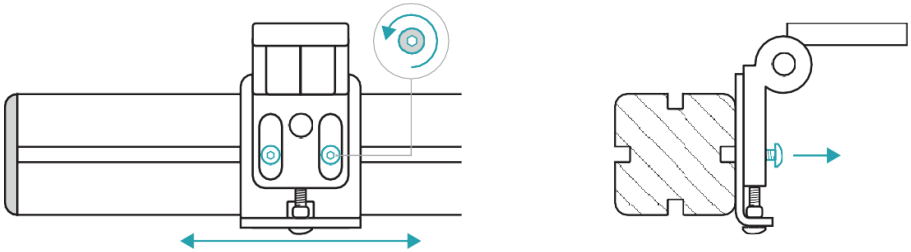

**** MINIMUM OF TWO OPERATIVES SHOULD BE UTILISED FROM HERE ON ****
**** KEEP TOP AND BOTTOM BATTENS ON MIRROR WHILST INSTALLING ****

02 LIFT MIRROR INTO PLACE

Lift mirror to horizontal and move into position on the Alavo system. Hold or prop the mirror open as shown below.

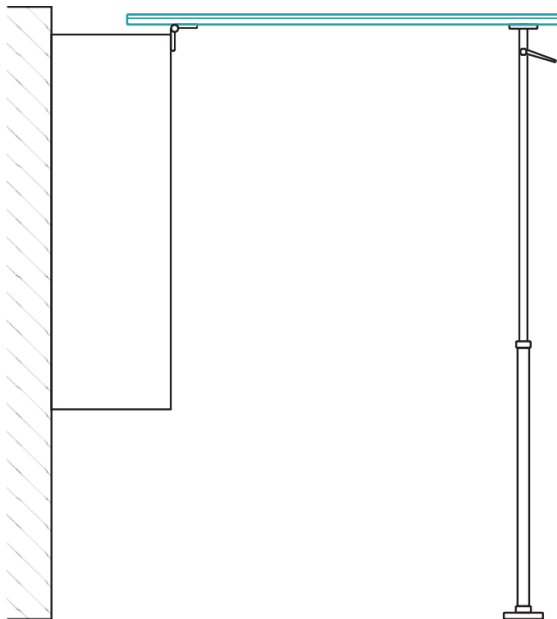

03 SLIDE HINGES INTO POSITION

Slide hinges into position to line up with mirror fixing holes.

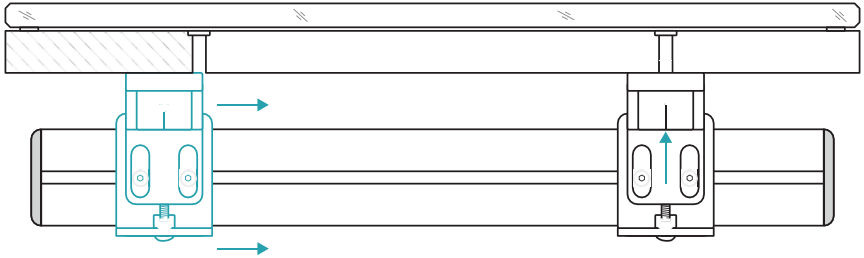

04 ATTACH HINGES ONTO MIRROR

Use attached bolts to fix hinges to the mirror.

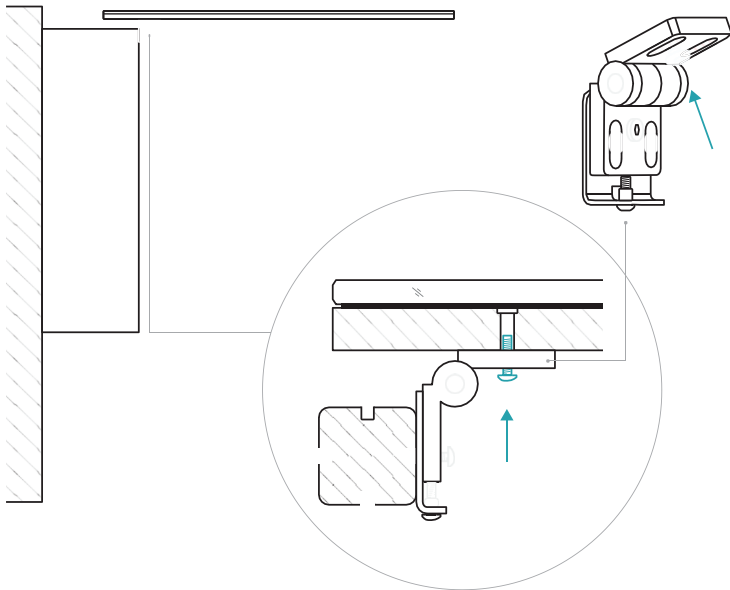

NOTE

Bolt must be inserted into round hole, not into slotted holes.

Take care not to cross thread the bolt as its counterpart insert cannot be replaced.

05 CLOSE MIRROR AND ALIGN

Remove prop and close the mirror. Then slide mirror along rail and line up with the alignment notch in the metal bottom plate as shown below.

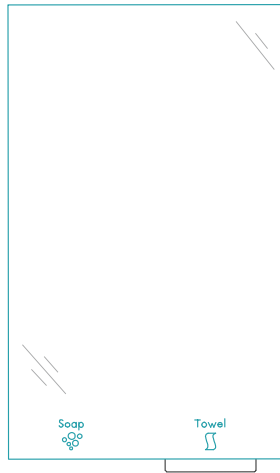

06 ATTACH GAS STRUTS ONTO MIRROR

Open the mirror to horizontal and prop open again. Ensure the ball joint is fully tightened against the strut at both ends. Then attach the gas strut to the mirror using the 90 degree bracket and bolts provided. Test by removing props whilst manually supporting the mirror to ensure gas struts are holding all the weight.

NOTE

The struts will already be attached to the module, with the chamber at the top.
The 90 degree bracket will already be attached to the gas strut.
Check that the ball joint on the 90 degree bracket is facing towards the nearest module cheek.
Take care not to cross thread the bolt as its counterpart insert cannot be replaced.

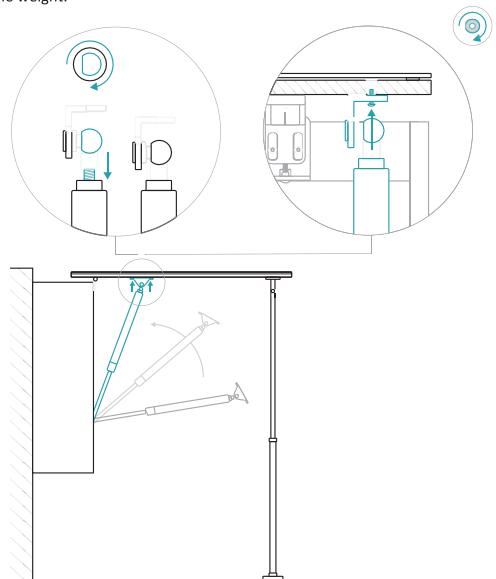

**** OPEN MIRROR SLOWLY AND WITH CAUTION AT THIS STEP AS GAS STRUTS WILL BE FULLY CHARGED - THIS COULD RESULT IN THE MIRROR OPENING WITH EXCESSIVE FORCE UNTIL ADJUSTED AS PER STEP 07 ****

07 ADJUST PRESSURE IN GAS STRUT

To adjust gas pressure, slacken grub screw in short bursts, and maintain equal pressure between strut pairs.

NOTE

Test mirror weight repeatedly to ensure sufficient gas remains.

Do not over-tighten grub screw.

**** RELEASE GRUB SCREW IN SHORT BURSTS AND WITH CAUTION ****

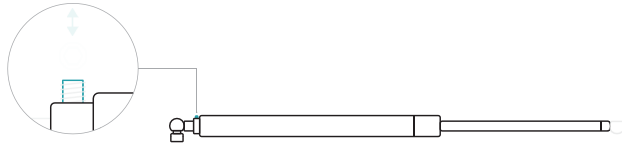

**** REPEAT STEPS 01 - 07 FOR ALL SUBSEQUENT MIRRORS ****

08 FIX REFILL LIGHT BOARD TO MIRROR

Position refill light board onto back of mirror by locating the pilot holes which are indicated on the project drawings. Fix the board to the mirror using the screws provided.

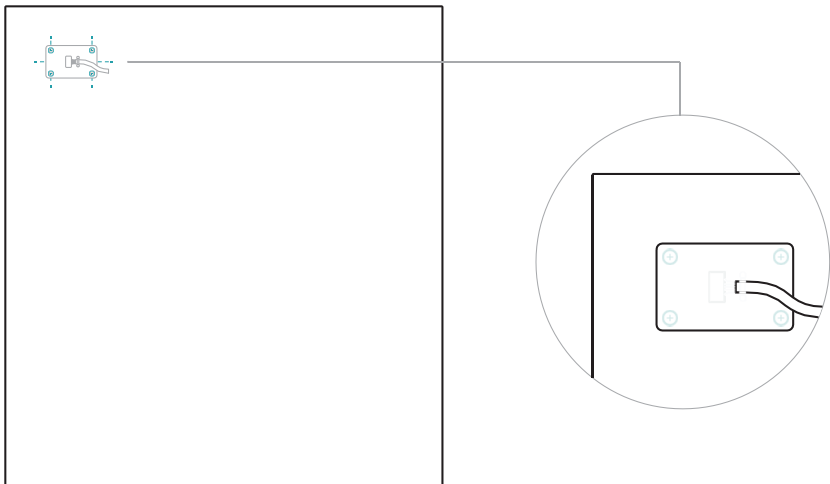

09 ADJUST MIRROR POSITIONS

Use the bolts on the hinges to adjust the mirror as necessary.
Then tighten all hinge bolts and recheck all mirrors are level with equal gaps.

NOTE

Ensure hinge fixing bolts are slack before adjusting mirror.

Mirror should be opened carefully ensuring edges do not conflict.

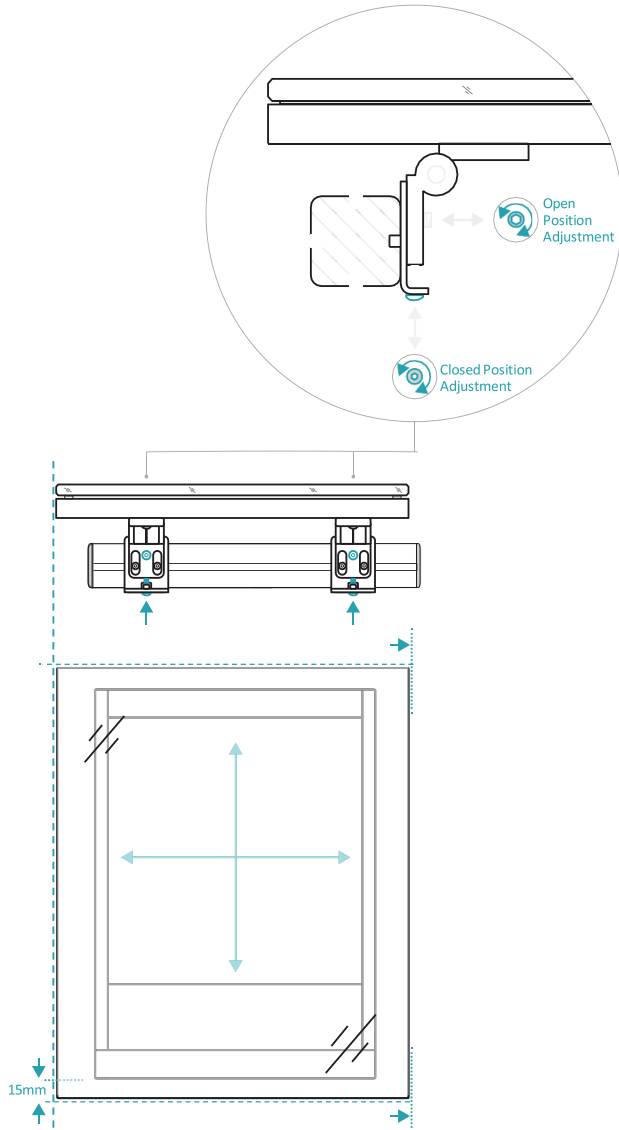

10 FIX LOCK KEEP ONTO MIRROR

Locate lock keep onto back of mirror by finding the pilot hole which will be indicated on the project drawings.
First fix one screw centrally in the slotted hole to allow for adjustment.

NOTE

Ensure the slotted hole is nearest to the bottom of the mirror.

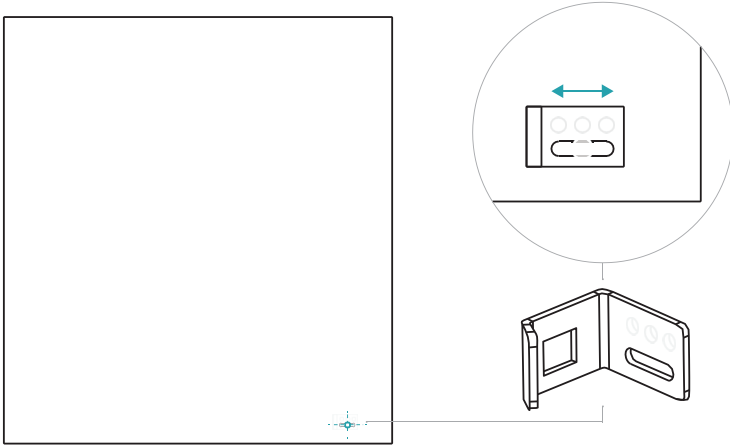

11 ADJUST AND SECURE LOCK KEEP

Close the mirror and check the lock latches automatically with its counterpart.
Adjust as necessary and fix in place with remaining screws.

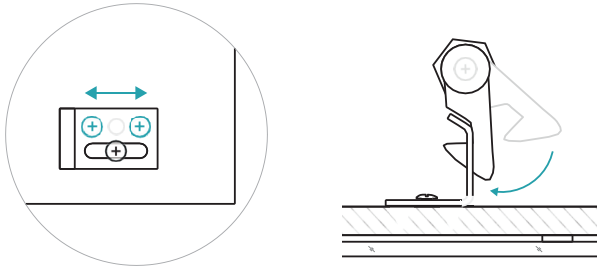

12 STICK MOUNT BUTTONS ON MIRROR

Stick mount buttons on back of mirror where the module and the mirror make contact.
This creates a soft close buffer when shutting the mirrors.



INSTALLATION AND

COMMISSIONING CHECKLIST

VISUAL AND FUNCTIONAL CHECKS

Ensure all visual and functional checks have been carried out to check Alavo has been delivered and installed successfully.

01 PROJECT DETAILS

Project reference number:

System number:

Location:

02 VISUAL CHECKS

- Mirror condition is excellent
- Mirror alignment is correct - 3mm gaps between mirrors and all mirrors align with their corresponding alignment notch
- All plumbing and soap connections are pushed up to depth markers
- Soap tubing is straight and level across system without undulations
- Foaming soap solution is supplied - **important not to use liquid soap**

03 ACTIVATE ALAVO SYSTEM

Turn on power supply to the system

Turn on water supply to the system and check for leaks

Activate Alavo by turning on the RCD and the MCB switches

Wait 30 seconds for system to initialise

Tap will discharge momentarily to show they have been activated

04 FUNCTIONAL CHECKS

- | | |
|--|--|
| <input type="checkbox"/> Mirror latch and lock securely | |
| <input type="checkbox"/> Gas struts support weight of mirror | |
| <input type="checkbox"/> Light sensor is operating correctly - circle located at the top left of Alavo | Cover with hand to check - lighting will turn off
See O&M guide for light sensor adjustment |
| <input type="checkbox"/> Soap/paper refill light is illuminated | See O&M guide for refill light details |
| <input type="checkbox"/> Service key switch is working | In service mode taps and soap dispensers will be disabled - refill light will be red |
| <input type="checkbox"/> All icon lights are illuminated | If installed |
| <input type="checkbox"/> All halo lights are illuminated | If installed |
| <input type="checkbox"/> All through mirror lights are illuminated | If installed |
| <input type="checkbox"/> Colour and brightness of lights - can be adjusted | See O&M guide for light adjustment |
| <input type="checkbox"/> Hand dryer activate when hands placed under sensor | |
| <input type="checkbox"/> Soap dispensers discharge when hands placed under sensor | |
| <input type="checkbox"/> Tap discharges when hands placed under sensor | |
| <input type="checkbox"/> Water output temperature from TMV is correct and conforms to regulations | See O&M guide for adjusting TMV
TMV - Thermostatic Mixing Valve |

05 ACTIONS

- Cleaners/facilities staff familiarised with Alavo and the relevant instructions for cleaning and maintenance
- Cleaners/facilities staff shown how to put unit into service mode with key-switch for cleaning and maintenance
- Cleaners/facilities staff advised to refill Alavo with foaming soap solution **ONLY** and not liquid soap

06 SIGN OFF

Commission completed by: _____

Signed: _____

Date: _____

LIGHT CONTROL

LIGHTS ON ALAVO

The lights integrated into the Alavo system are displayed below.

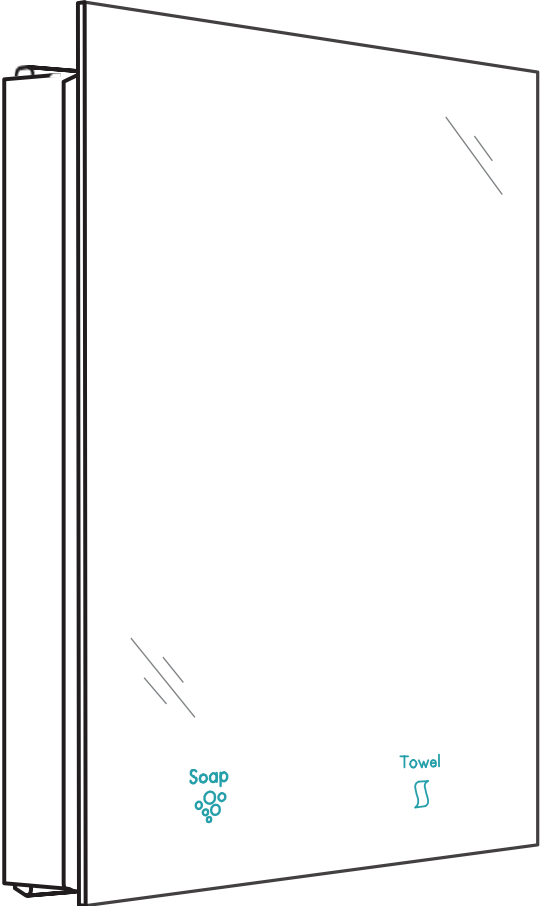

LIGHTS

- Halo Lights - Bottom
- Icon Lights

HOW TO ADJUST LIGHTS

Locate light adjustment controls on the front of the Alavo control box as displayed below.

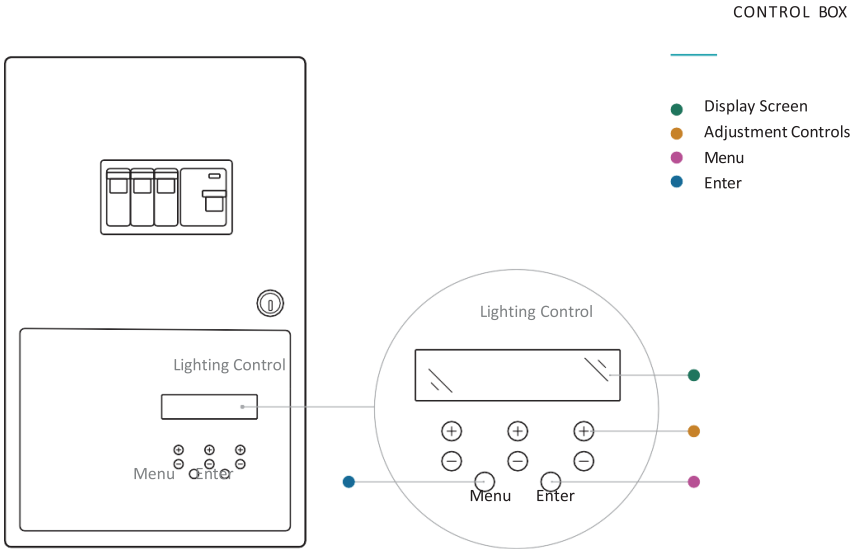

01 PRESS MENU

To activate screen

02 PRESS MENU TO SCROLL OPTIONS

03 PRESS ENTER

On the option to be adjusted.

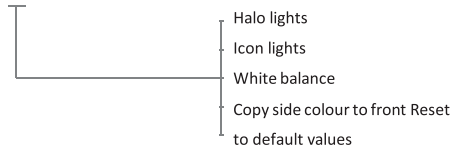

04 USE TO ADJUST

To desired values.

05 PRESS ENTER

To confirm values and return to options

Dolphin,
Southpoint, Compass
Park, Junction Road,
Bodiam TN32 5BS
United Kingdom
T +44 (0)1424 202 224
info@dolphinsolutions.co.uk
dolphinsolutions.co.uk

© Dolphin Solutions Ltd.